

CUMULUS

6976 | 6977 | 6978 | 9714

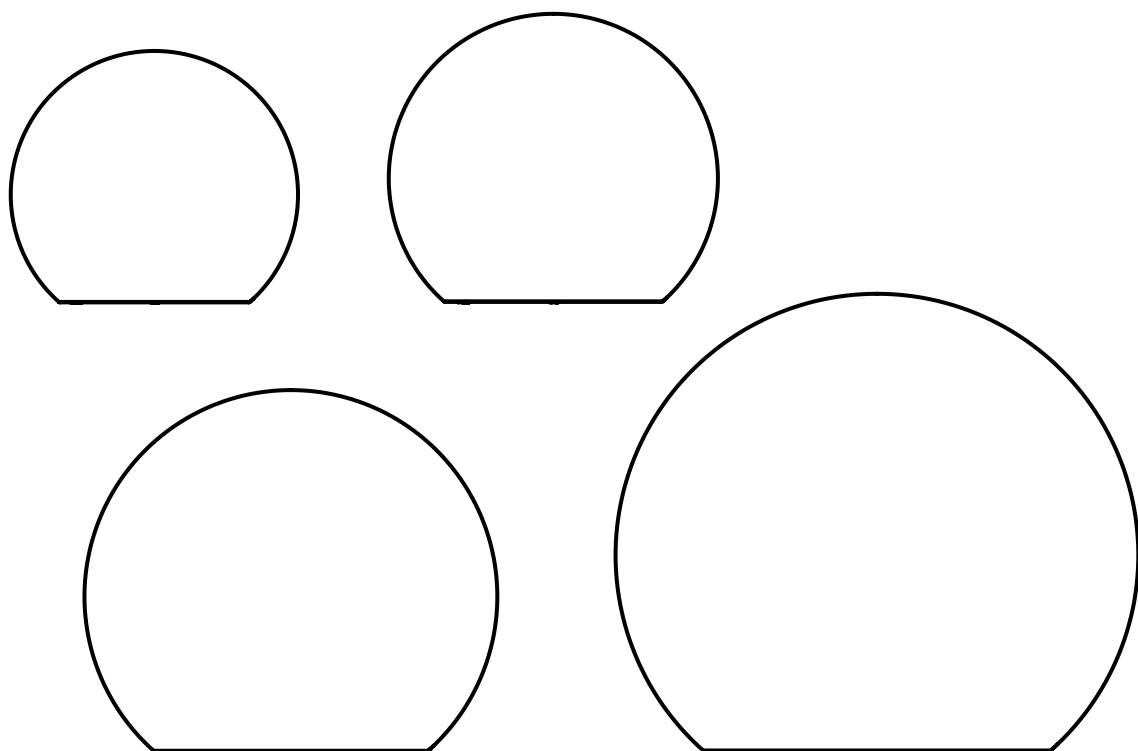

PL Możliwość zastosowania ze złączkami do przewodów WATER-PROOF CONNECTOR 8845, 8846

EN Can be used with WATERPROOF CONNECTOR 8845, 8846

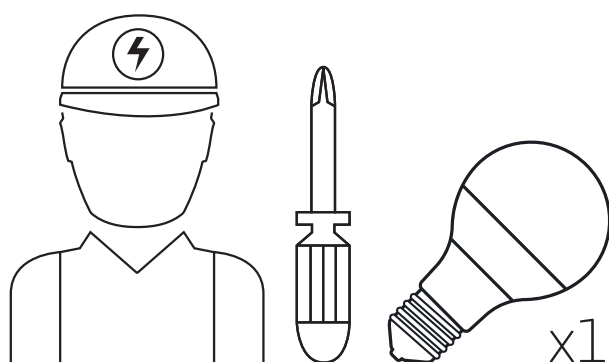

PL Aby zminimalizować ryzyko uduszenia, giętkie przewody podłączone do tej oprawy należy skutecznie przymocować do ściany, jeśli znajdują się one w zasięgu rąk.

EN To minimize the risk of suffocation, flexible wires connected to this luminaire must be securely fastened to the wall, if they are within arm's reach.

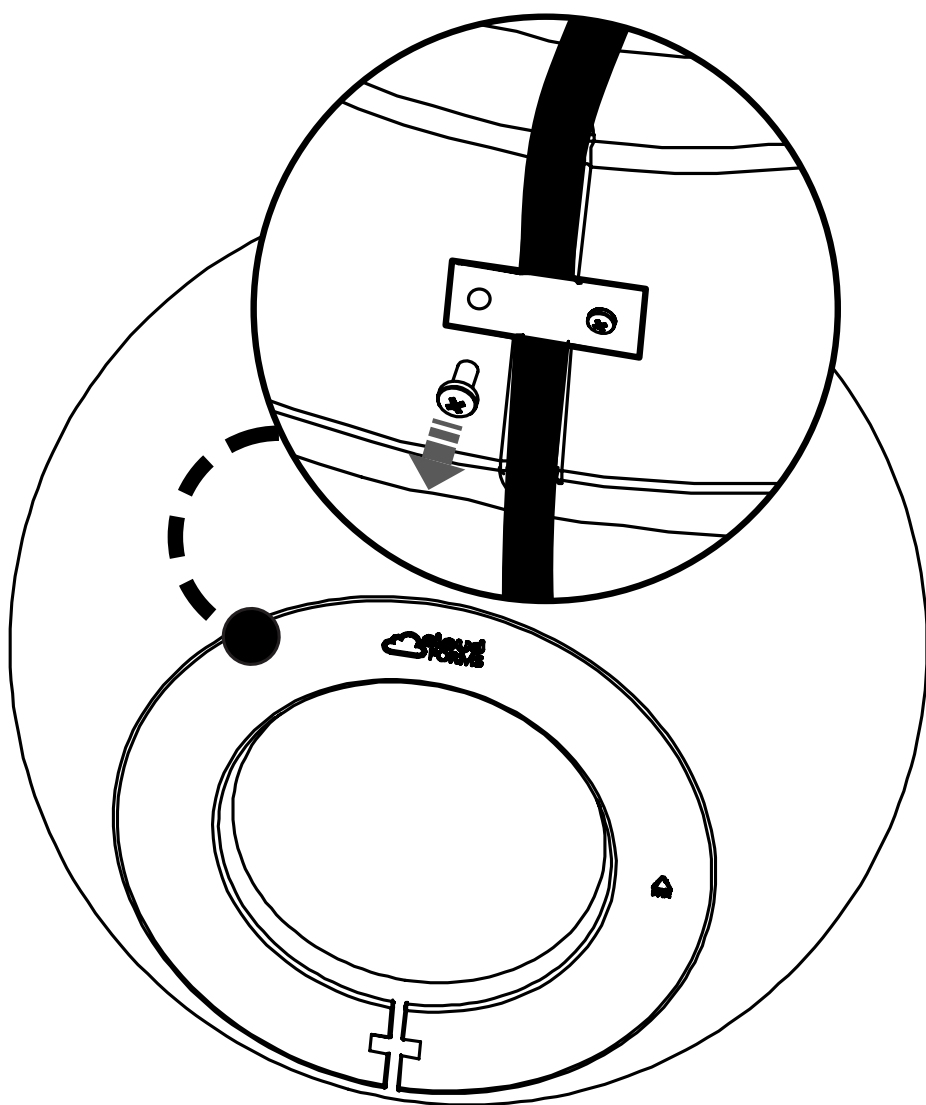

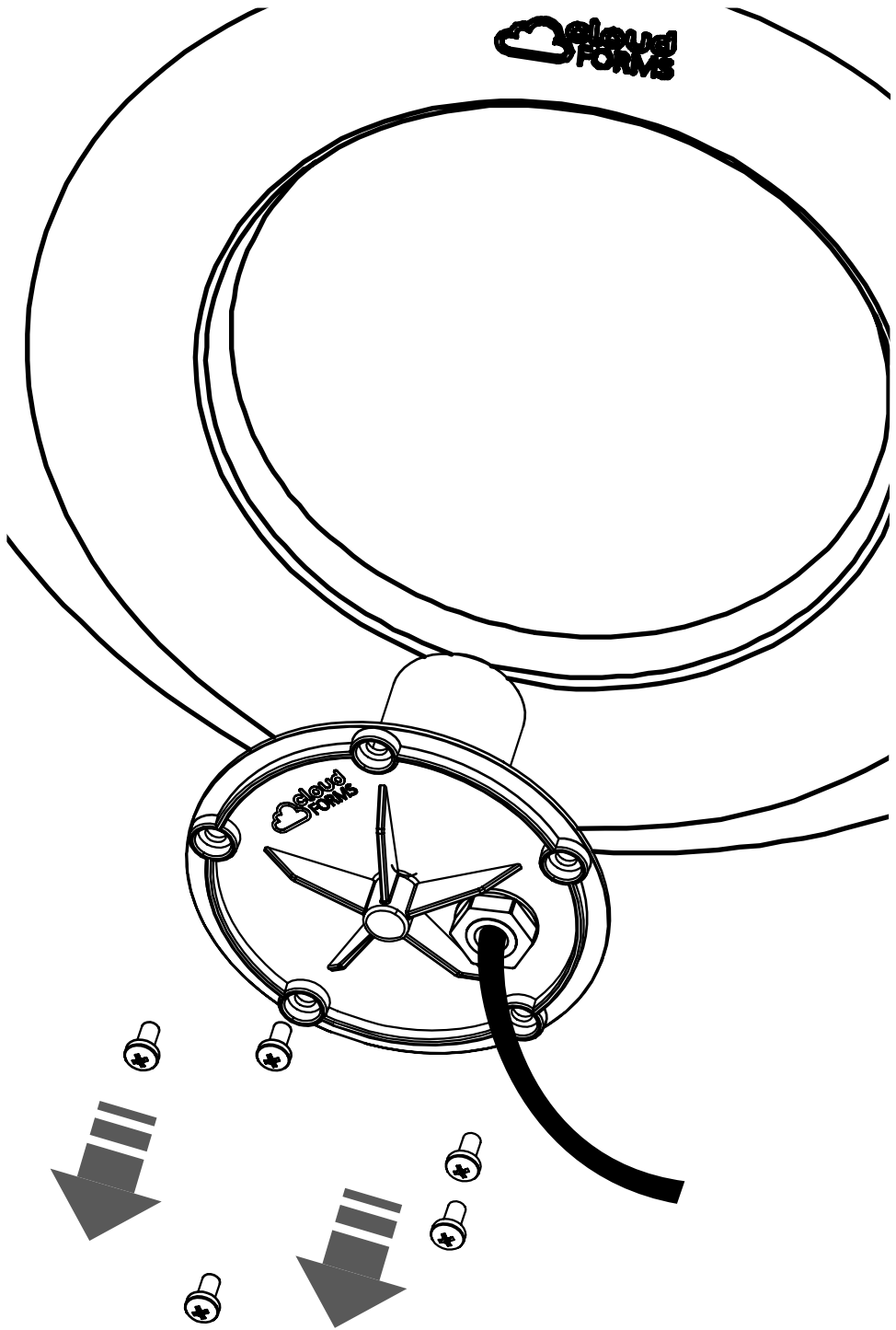

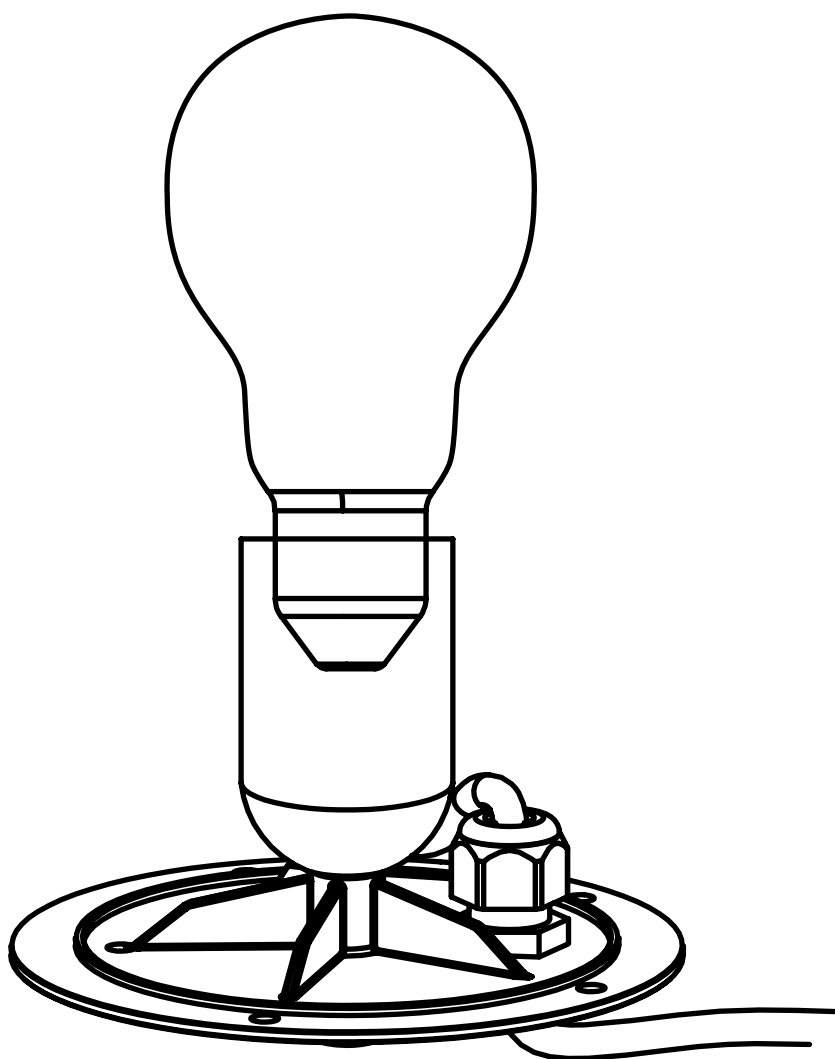
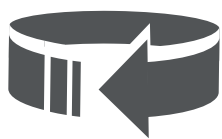

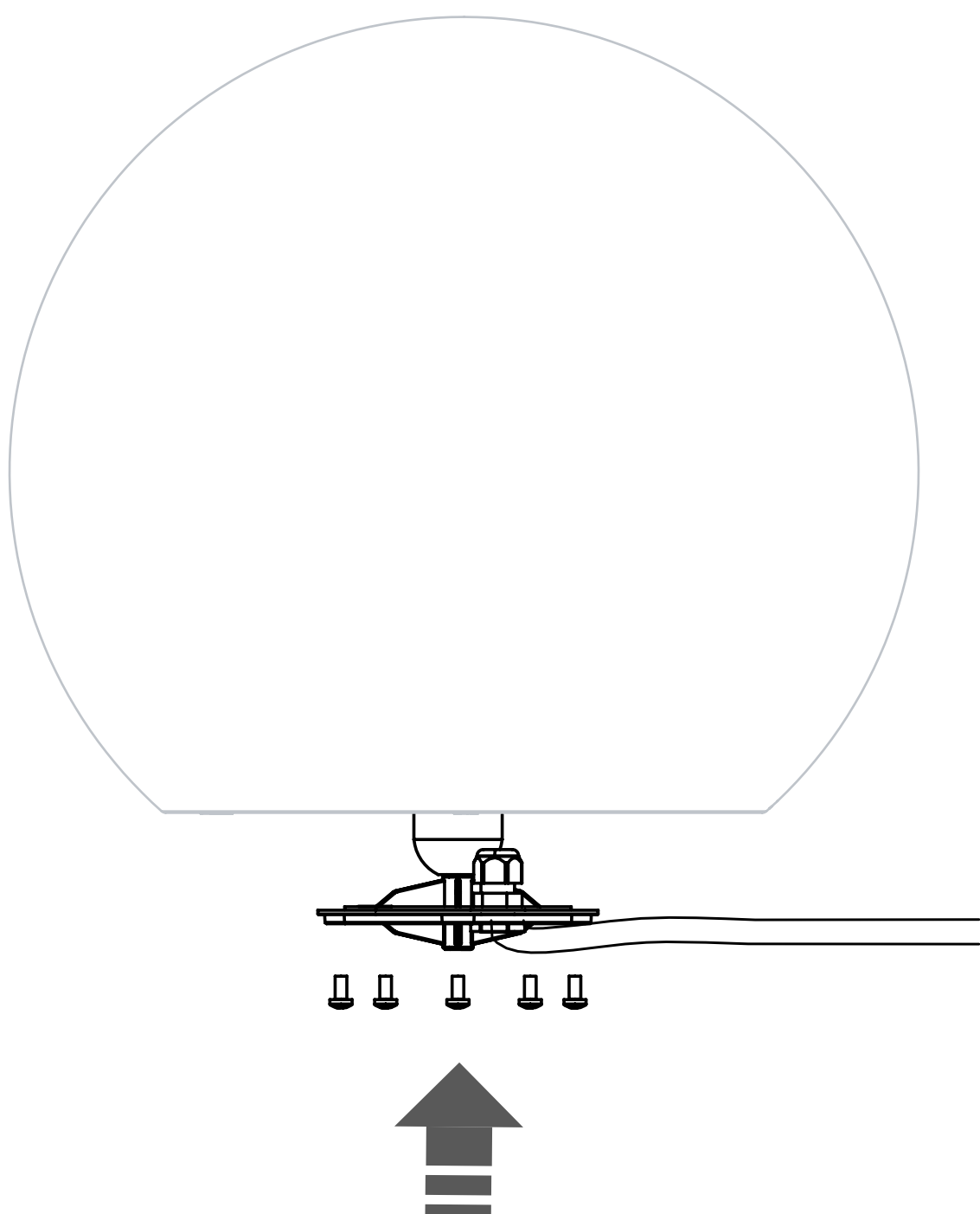

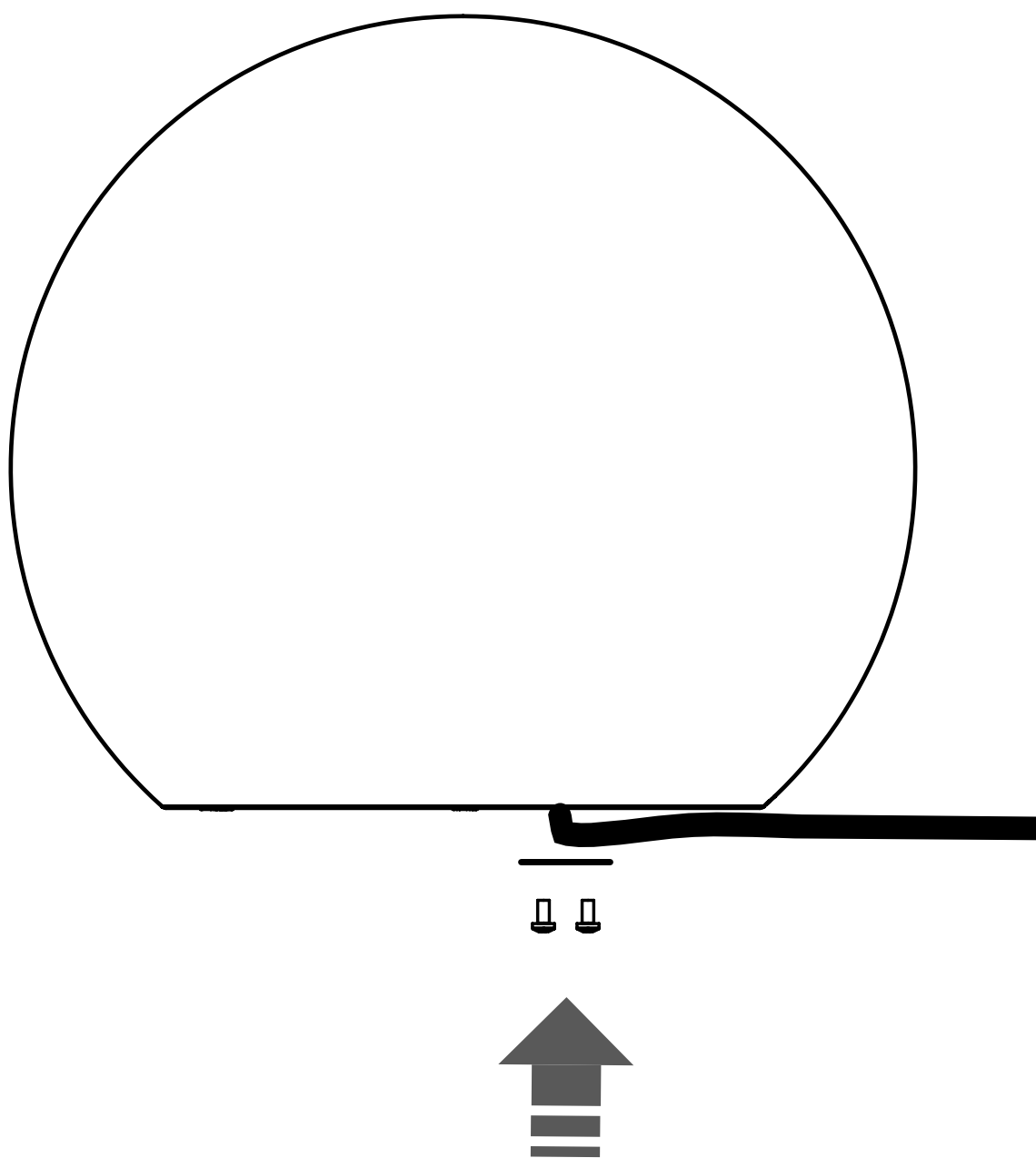

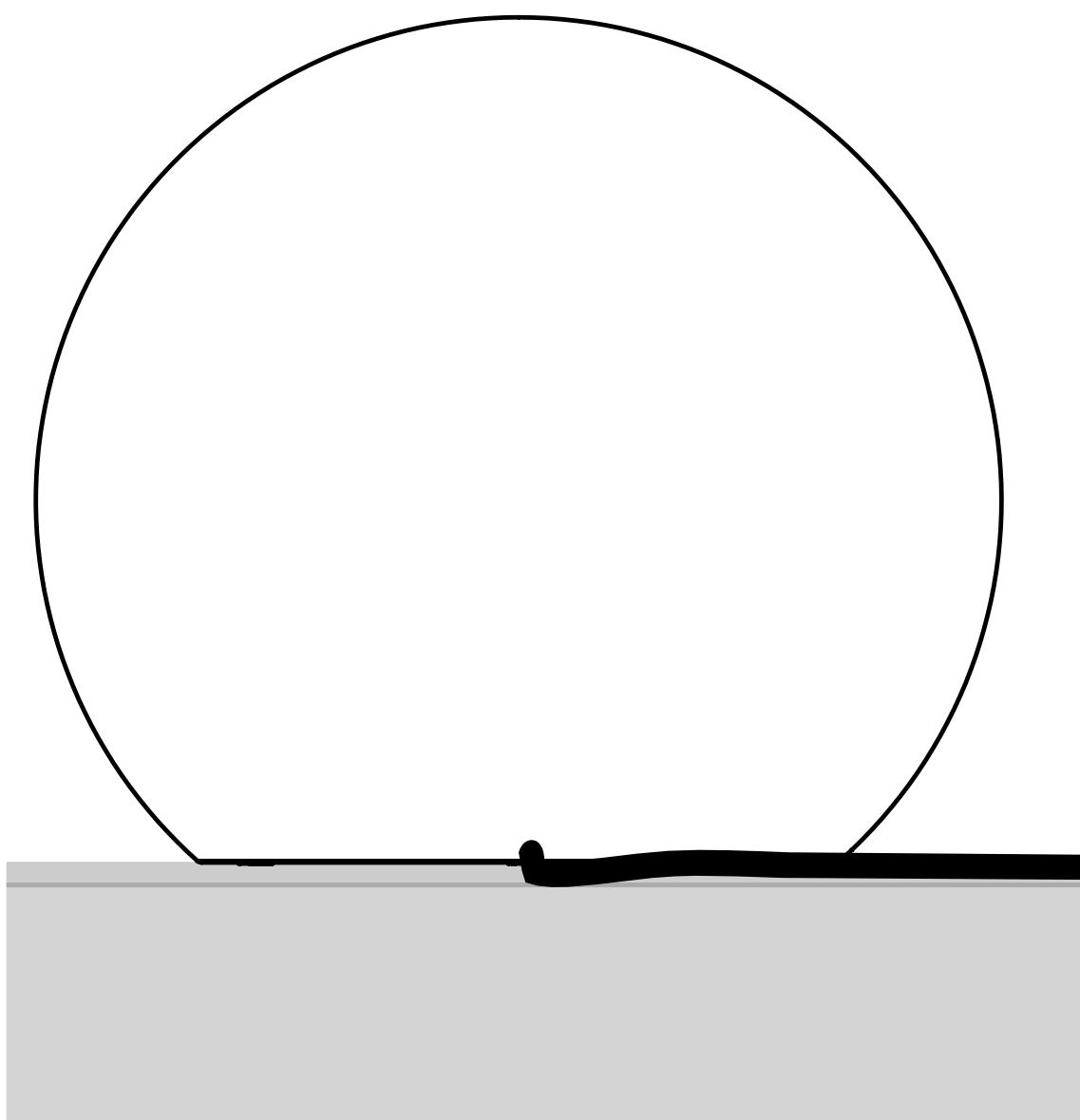
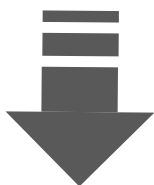

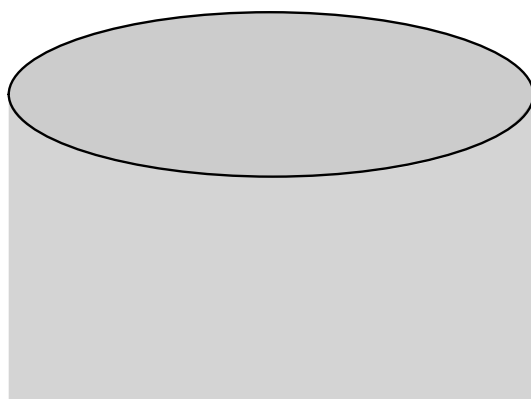
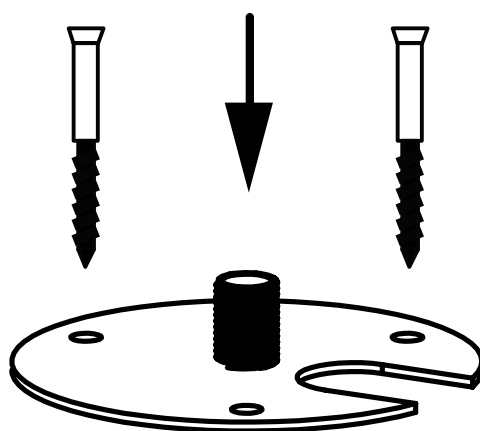
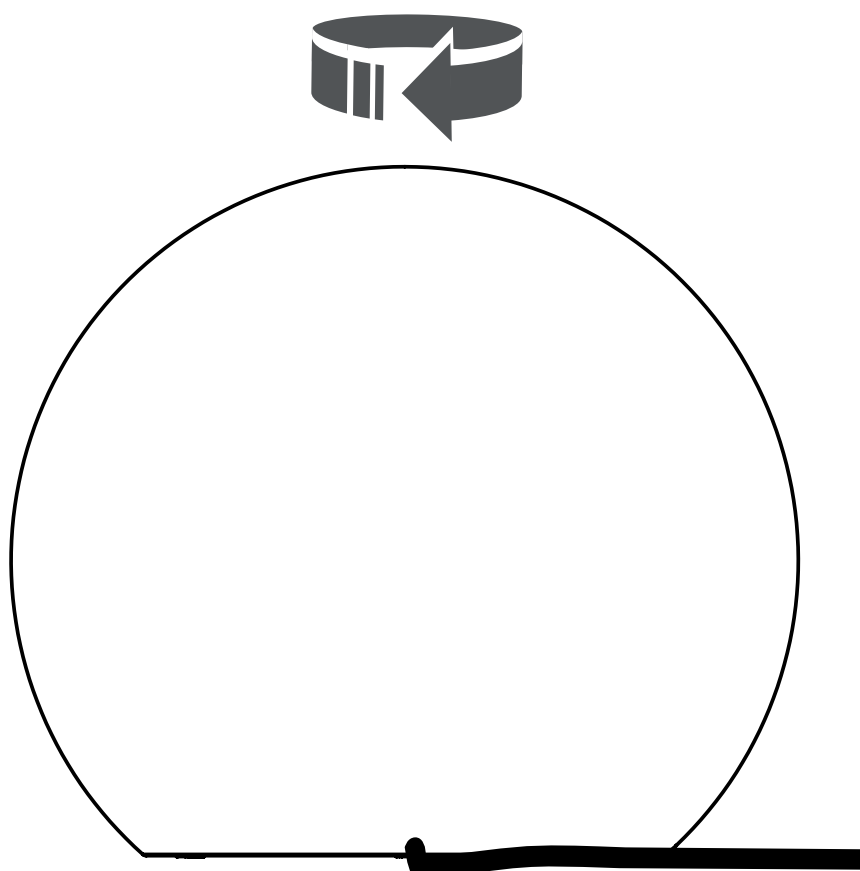

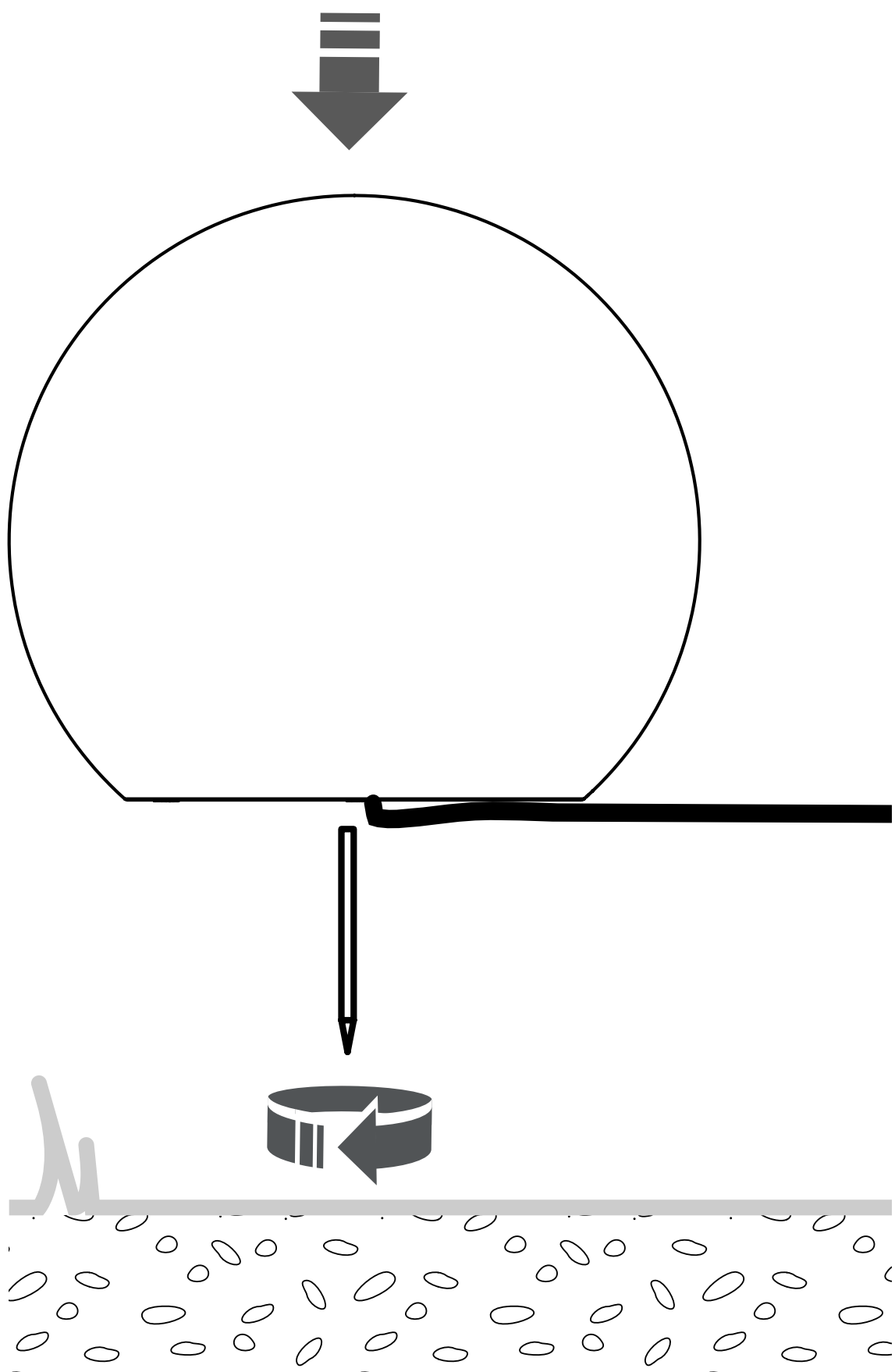

CUMULUS



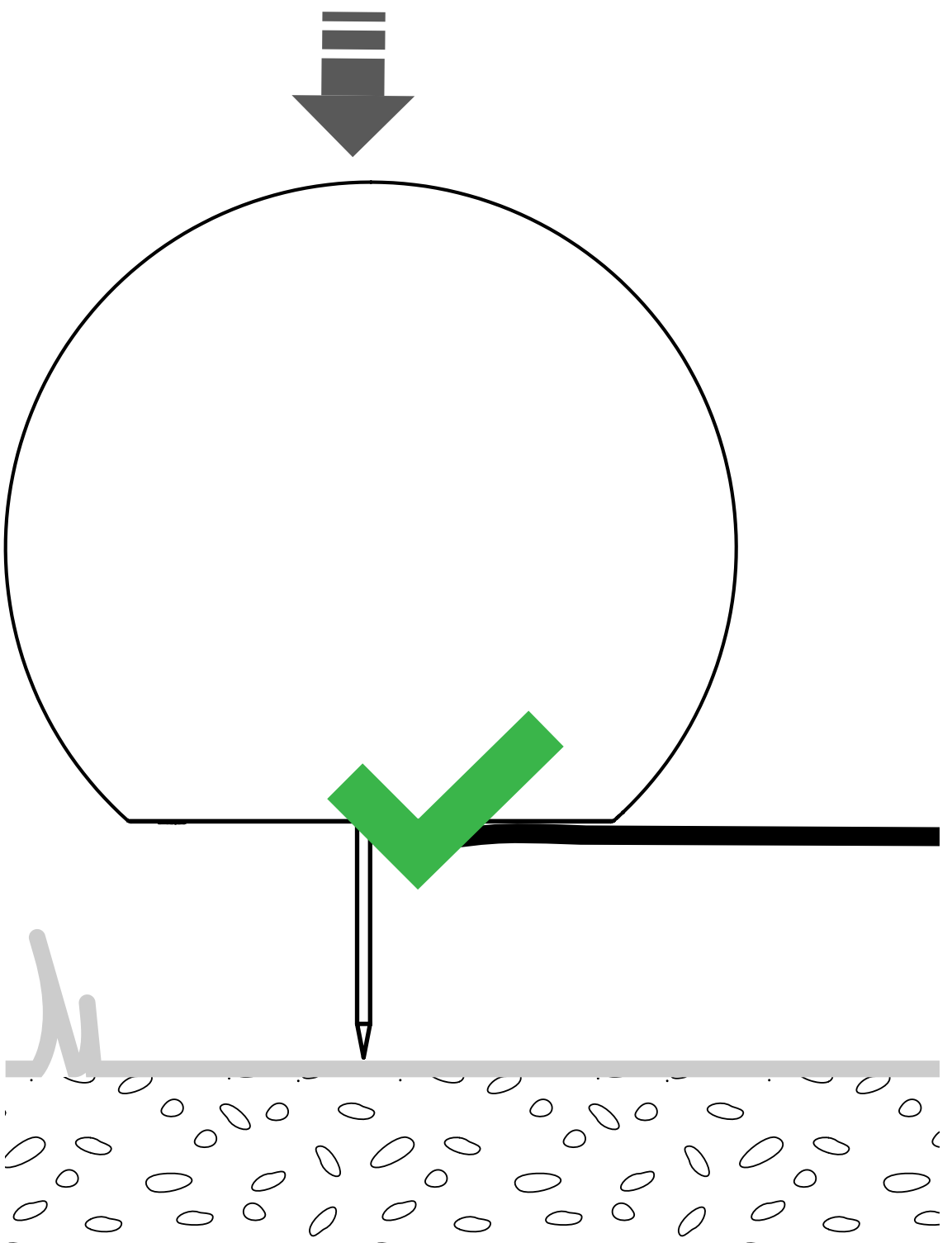

CUMULUS



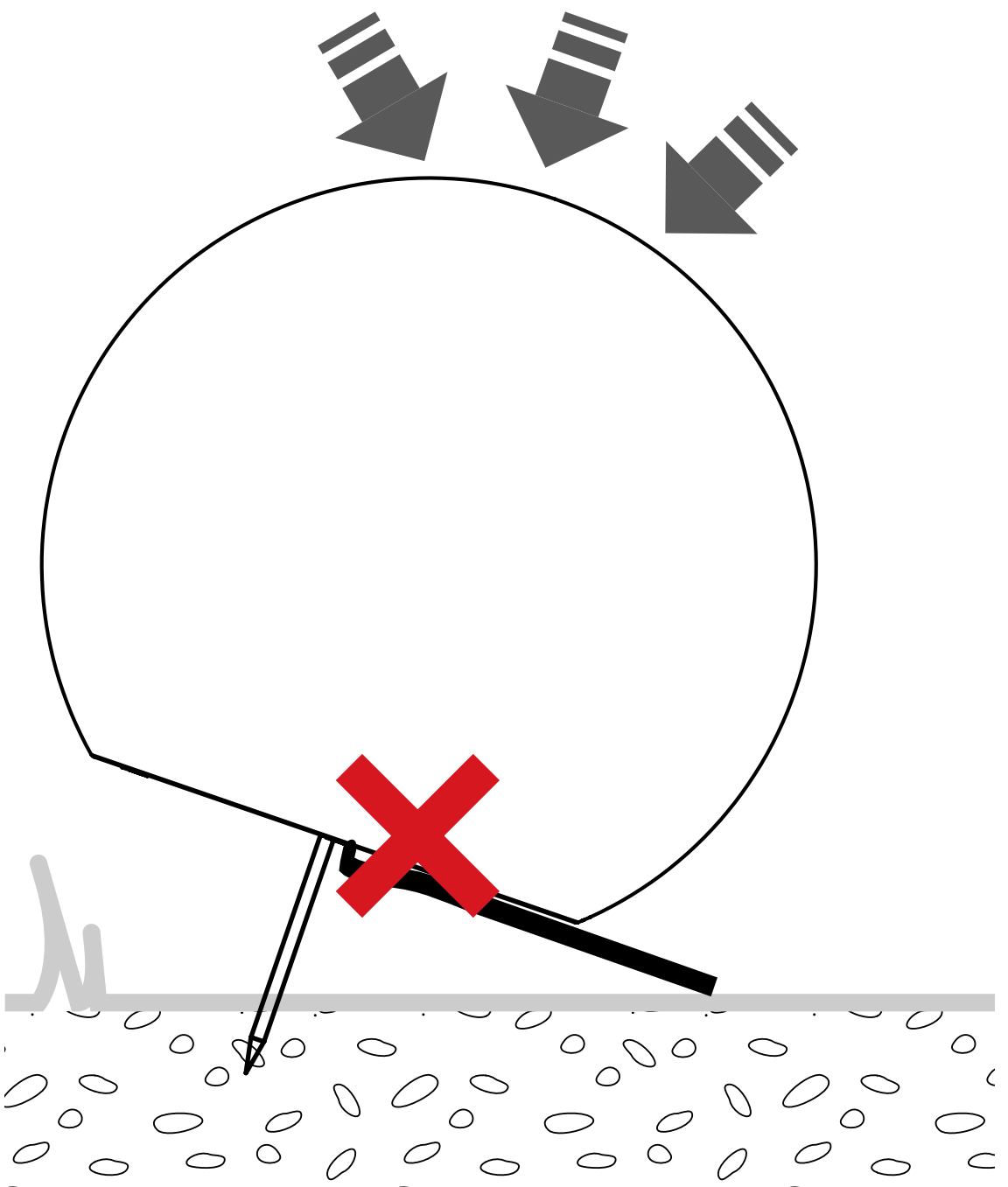

CUMULUS

