

EYE SUPER

6487

6494

6501

1

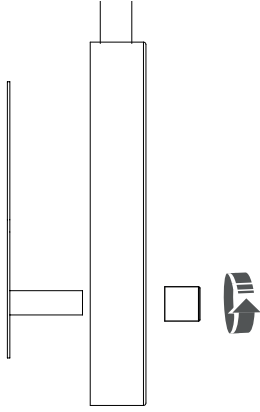

2

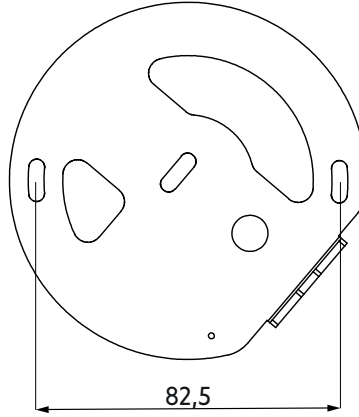

3

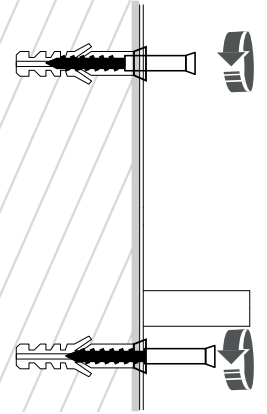

4

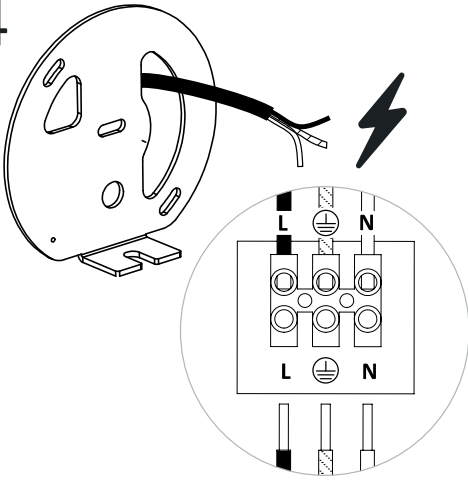

5

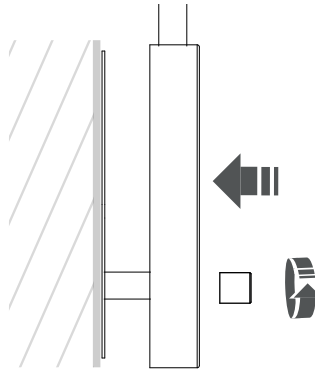

6

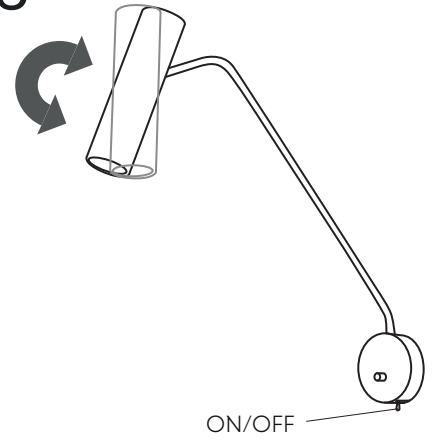

7

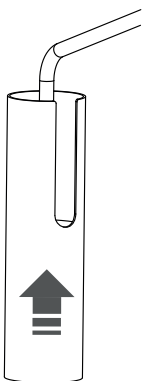

8

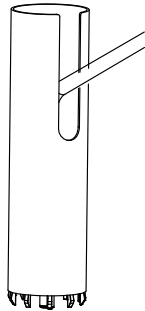

9

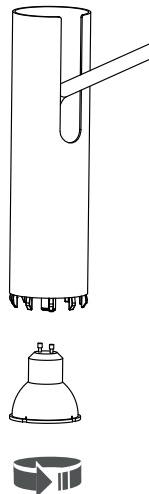

!

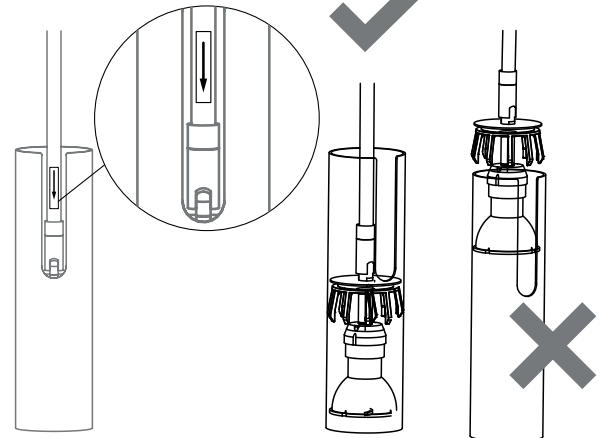

PL**UWAGA !!!**

Przy regulacji kierunku źródła światła nie wolno na siłę pokonywać oporu blokady.

EN**ATTENTION !!!**

When adjusting the direction of the light source, do not force the rotation past the blockade resistance.

RUS**Внимание!**

При регулировании направления источника света не следует силой форсировать блокаду его оборота.

LV**UZMANĪBU !!!**

Regulējot gaismas avota virzienu, nepieļaujiet rotāciju pāri blokādes pretestībai.

NL**LET OP!!!**

Bij het draaien van de lamp deze niet voorbij de blokkering forceren.

D**Achtung:**

Um ein überdrehen & ausbrechen der Gelenke zu vermeiden, justieren Sie die Leuchte nur innerhalb der gezeigten Raien.

CZ**POZOR !!!**

Při nastavování směru světelného zdroje nevytáčejte světlo silou za povolenou hranici.

IS**ATHUGIÐ !!!**

Þegar stefna ljósgjafans er stillt má ekki þvinga honum lengra en hann kemst.

SK**Pozor!**

Pri nastavovaní smeru svetelného zdroja, nevytáčajte svetidlo za povolenú hranicu.

H

A lámpa irányának beállításakor csak annyira változtassa a karok állását, hogy azok ne feszüljenek túl.

RO**ATENȚIE!!!**

Cand ajustati directia corpului de iluminat, nu fortati rotatia peste rezistenta de blocare.

SLO**OPOZORILO!**

Ko na svetilki nastavljate smer svetlenja te NE obračajte na silo preko mehanske blokade.

SRB**PAŽNJA!!!**

Kada podešavate pravac izvora svetlosti, ne rotirajte preko blokade.

HR**POZOR!!!**

Prilikom usmjeravanja, zakretanja, svjetlosnog izvora ne primjenjivati silu kada zglob dosegne krajnju poziciju.

F**ATTENTION !!**

Pour orienter la lampe, débloquez la vis de serrage. Ne forcez pas sur la lampe quand elle est serrée afin de pas la détériorer.

N**OBS!**

Når du justerer retningen til lampen, ikke tvinge den forbi den inbygdde sperren på lampefestet.

B**Opgelet!!!**

Bij het richten van de lichtbron mag dit niet geforceerd worden voorbij het punt van blokkage.

S**Varning!**

Lamphuvudet har en inbyggd spärr för rotation, tänk på att INTE forcera denna då ni justerar riktningen på lampan.

P**ATENÇÃO !!**

Ao ajustar a direção do foco, não force a rotação depois da resistência do bloqueio.

FIN**Säädettäessä valaisimen suuntausta:**

Älä pakota nivelten pyörimistä estovastuksen yli.

GR**ΠΡΟΣΟΧΗ !!!**

Κατά τη ρύθμιση της κατεύθυνσης της πηγής φωτός, μην πιέζετε την περιστροφή πέρα από το σημείο αντίστασης αποκλεισμού.

AR

مامت‌هال!!!

عوض‌الاردصم‌هاجت‌اطبض‌دن‌ع
ةمواقم‌ال‌ل‌ع‌بل‌غت‌ال‌ن‌أ‌ب‌ج‌ي
ل‌ف‌ق.

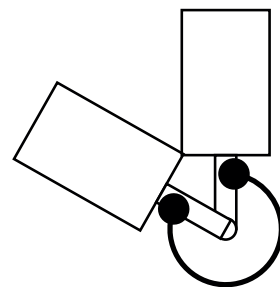

315°

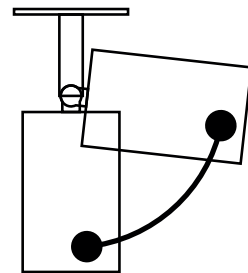

85°